

# CONERO

## Inside Pullout 72 H 475

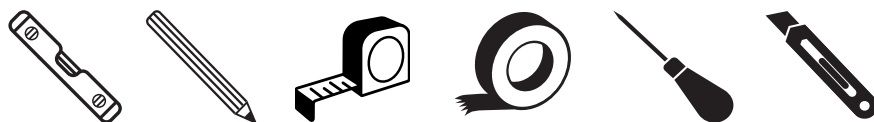

<http://support.kesseboehmer.de>

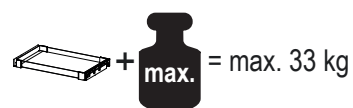
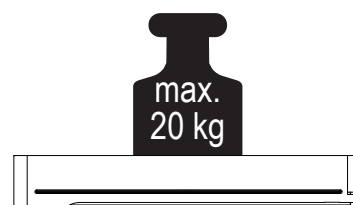
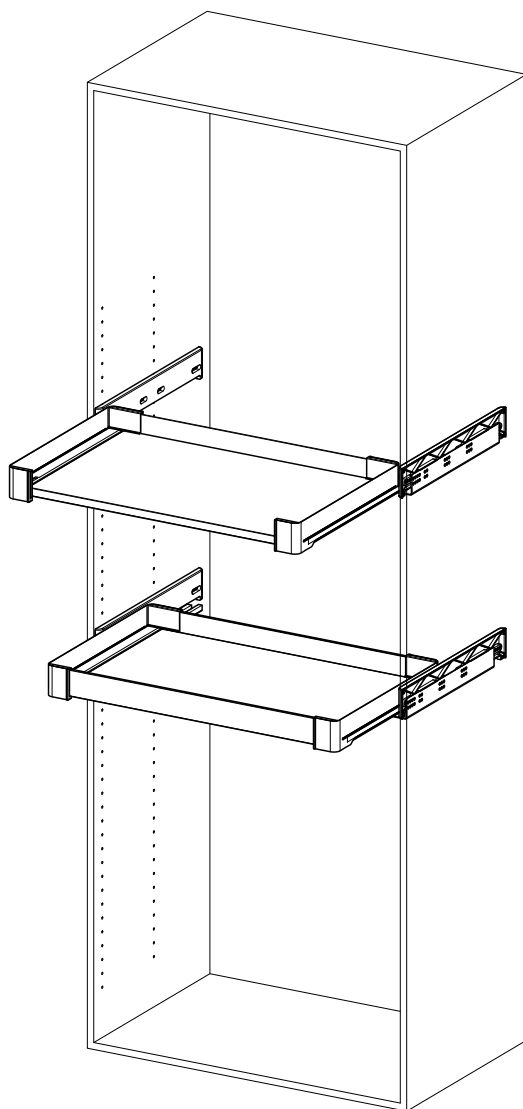
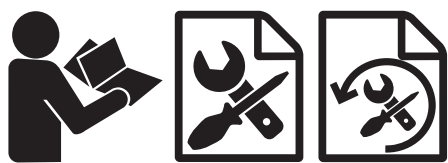

# CONERO

## Inside Pullout 72 H 475

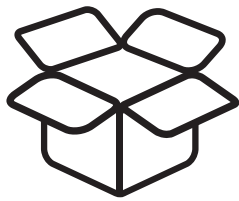

mm  
(inch)

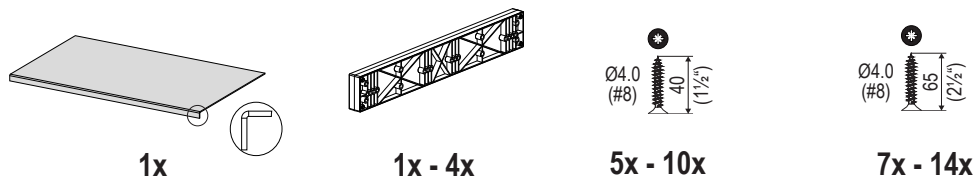
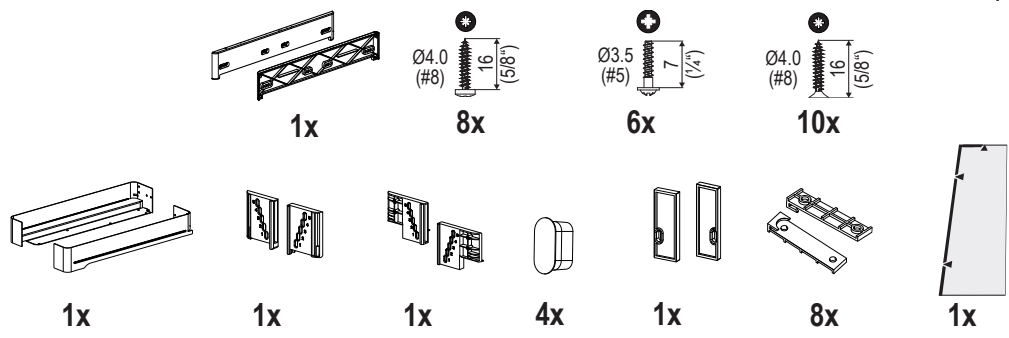

A

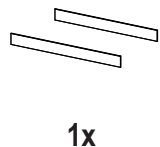
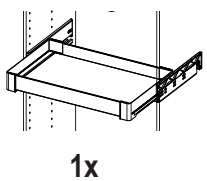

B

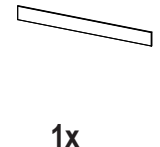
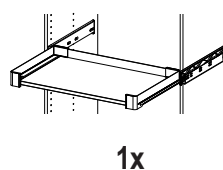

**DE** Die technischen Darstellungen und Maßangaben – auch bei Abbildungen und Zeichnungen – sind unverbindlich. Konstruktionsverbesserungen sind vorbehalten! **EN** Technical information and stated dimensions (including in illustrations and drawings) must not be regarded as binding. Design subject to improvement without notice! **FR** Les visuels techniques et dimensions – y compris les schémas et les illustrations – ne sont pas contractuelles. Sous réserve d'évolutions techniques! **IT** Le rappresentazioni tecniche e le indicazioni delle dimensioni – anche nelle figure e nei disegni – non sono vincolanti. Con riserva di miglioramenti di progettazione! **ES** Las imágenes técnicas y las indicaciones de medidas – también en imágenes y dibujos – no son vinculantes. Queda reservado el derecho de realizar mejoras en el diseño! **PT** Representações técnicas e dimensões – mesmo em ilustrações e desenhos – não são vinculativas. Reservado o direito a melhorias construtivas! **HE** כל התרשימים הטכניים והמידות – אף לגבי איורים ותכניות – הנם בלתי מחייבים. זכות לשינויים ושיפורים מבניים שמורה ליצרן! **FI** Tekniset piirroksat ja mitat – myös kuvissa ja piirroksissa olevat – ovat sitoumuksetta parantaviin muutoksiin pidätettään! **DA** De tekniske illustrationer og målangivelser – også på illustrationer og tegninger – er ikke bindende. Forbehold for designforbedringer! **CS** Technické popisy a rozměry, jakož i obrázky a výkresy, jsou nezávazné. Vyhrazujeme si právo na změny konstrukce! **PL** Prezentacje techniczne i wymiary – także na ilustracjach i rysunkach – nie są wiążące. Udoskonalenia konstrukcyjne są zastrzeżone! **RU** Иллюстрации технических деталей и указанные размеры, в том числе на рисунках и чертежах, являются ориентировочными. Компания оставляет за собой право на усовершенствование конструкции! **TR** Teknik sunum ve ölçü bilgileri (resim ve çizimlerde de) yasal olarak bağlayıcı değildir. Yapısal geliştirmeler yarma hakkı saklıdır! **BG** Техническото представяне и размерите, включително при изображенията и чертежите, са необвързващи. Запазваме си правото на конструктивни подобрения! **HU** A műszaki ábrázolások és méretadatok – ábránál és rajzoknál sem – nem kötelező érvényűek. A konstrukciós javítások joga fenntartva! **SR** Tehničke ilustracije i dimenzije – uključujući ilustracije i crteže – nisu obavezujući. Dizajn poboljšanja su rezervisana! **EL** Τα τεχνικά σχέδια και οι διαστάσεις – ακόμα και σε απεικονίσεις και σχέδια – δεν είναι δεσμευτικά. Με την επιφύλαξη τεχνικών βελτιώσεων! **JA** 図面の技術的説明と寸法 – すべてが法的に拘束力を持つものではない。改良設計の権利を留保する。 **CN** 技术说明和规格, 包括插图和图纸均不具约束力。保留改进设计的权利!

# CONERO

## Inside Pullout 72 H 475



**i**

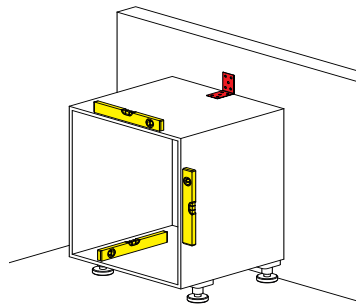
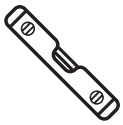

**1**

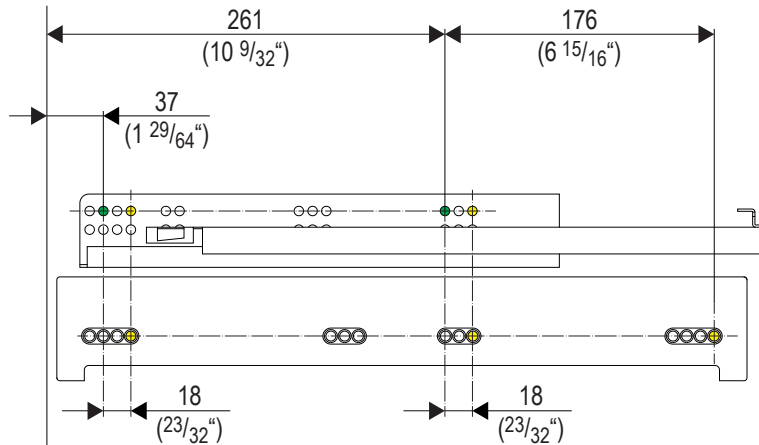
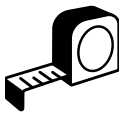

**1a.1**

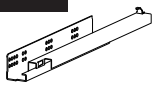

1x

PZ2

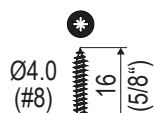

2x

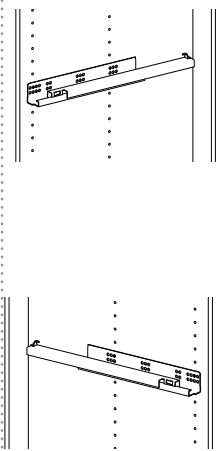
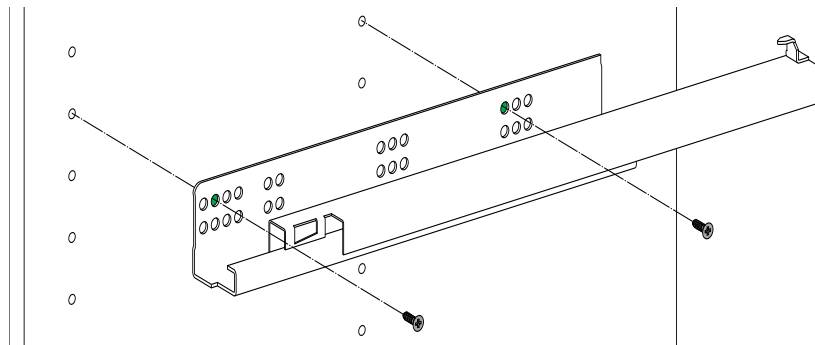

**1a.2**

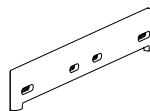

1x

PZ2

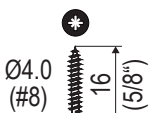

3x

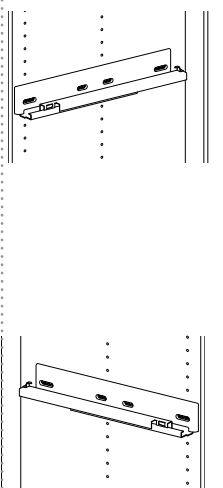
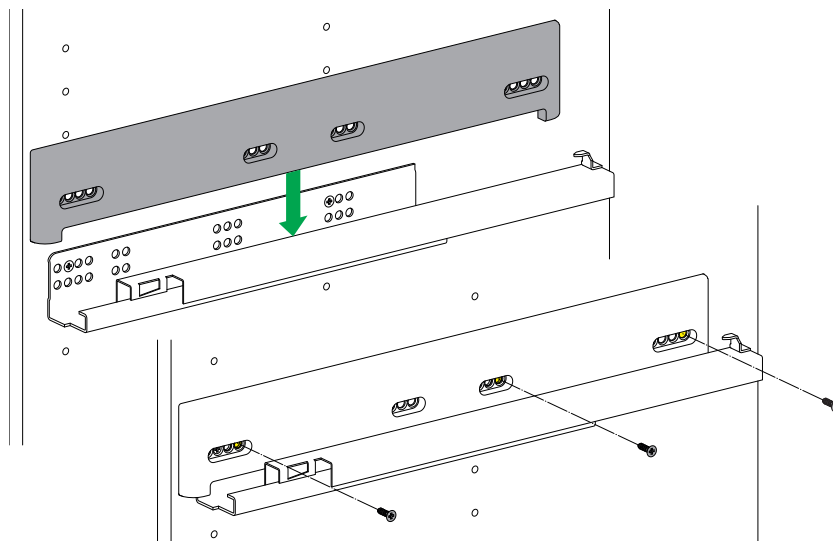

# CONERO

## Inside Pullout 72 H 475



### 1b.1

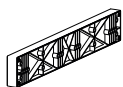

1x

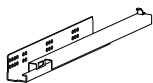

1x



PZ2

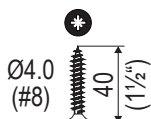

2x

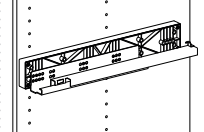
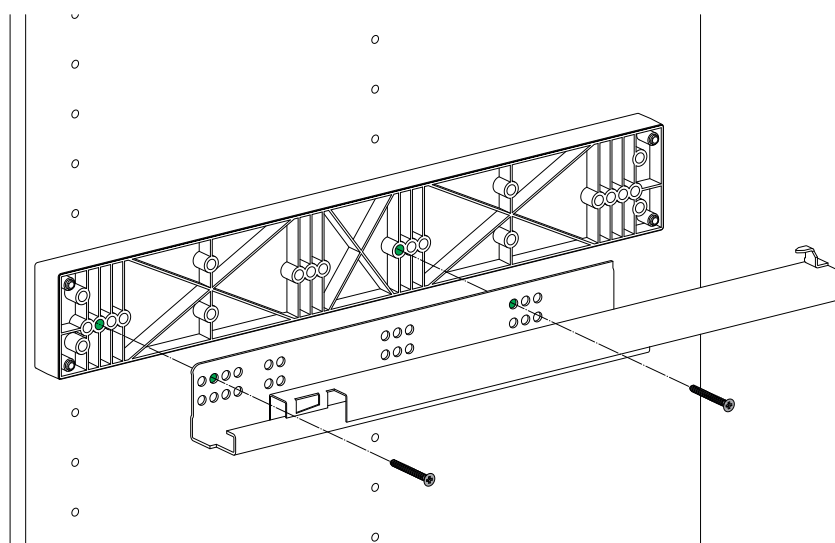

### 1b.2

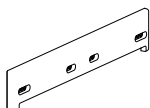

1x



PZ2

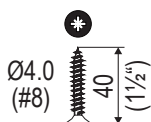

3x

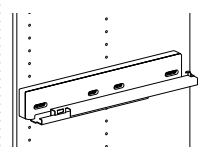
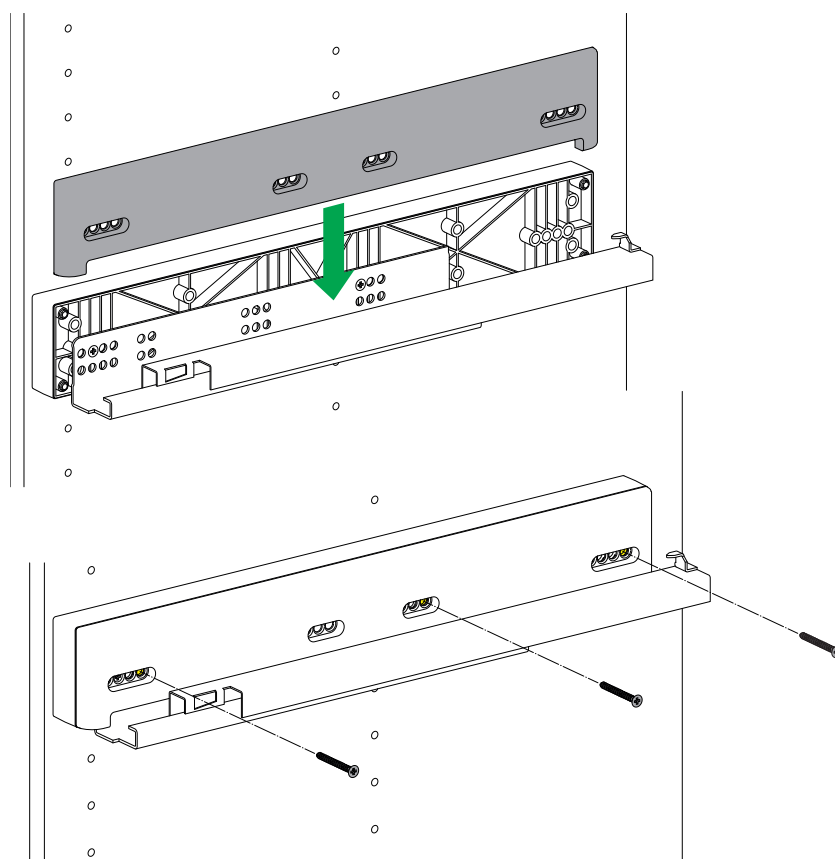



# CONERO

## Inside Pullout 72 H 475



### 1c.1

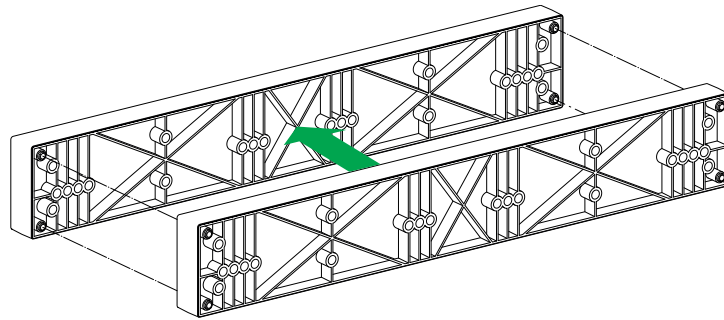
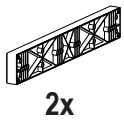

### 1c.2

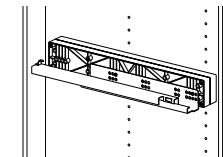
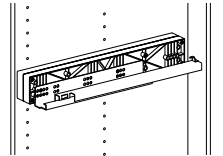
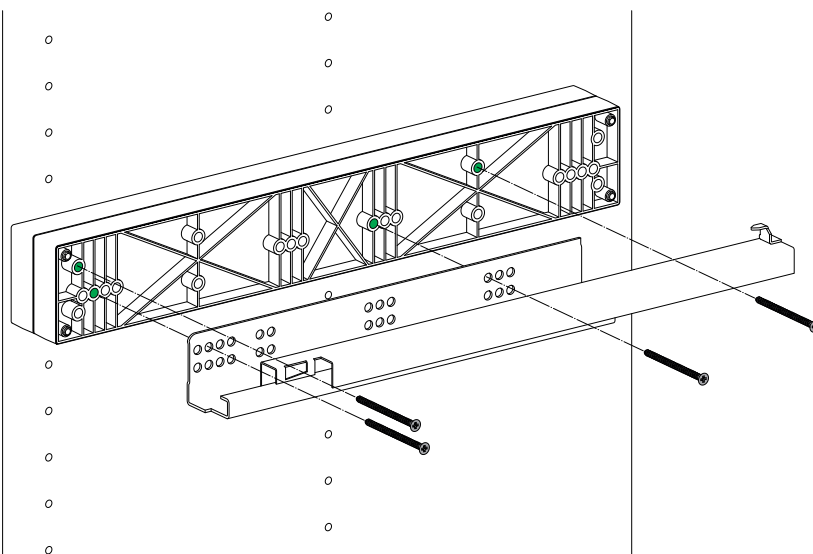
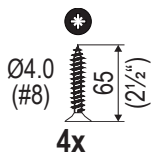
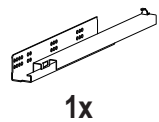
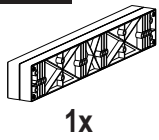

### 1c.3

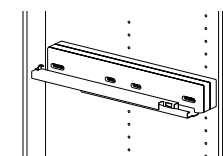
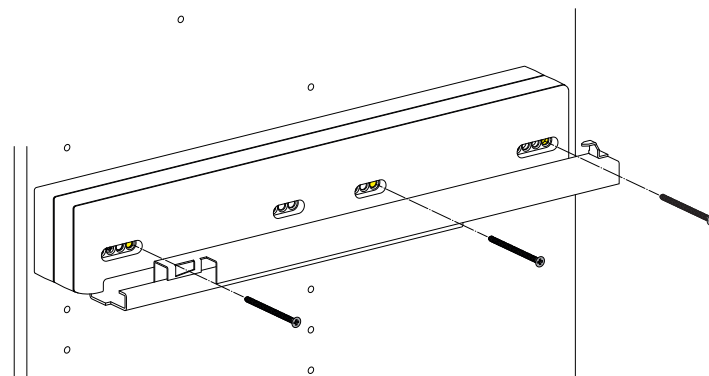
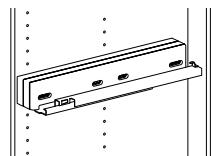
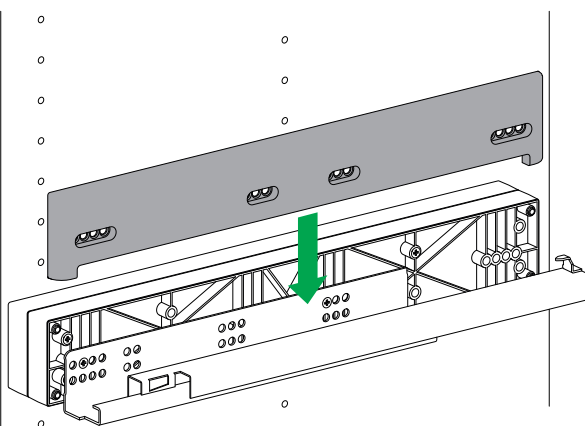
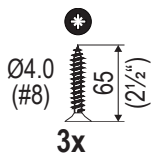
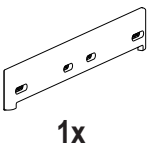

# CONERO

## Inside Pullout 72 H 475



**i**

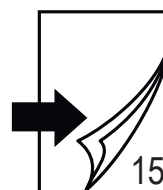
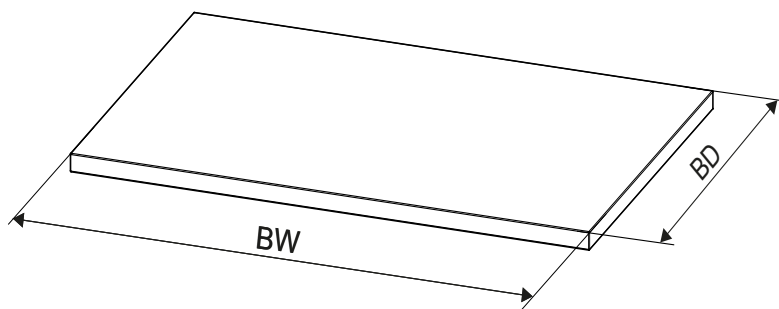

**i**

**2**

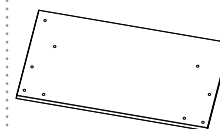
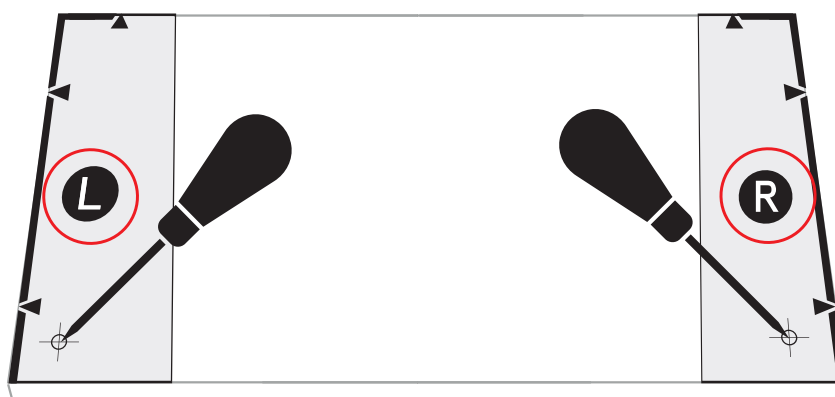
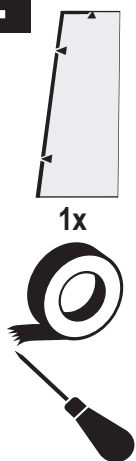

**3a**

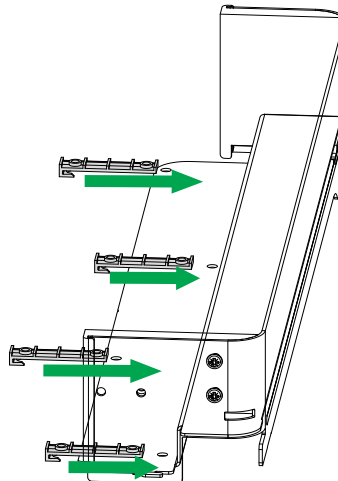
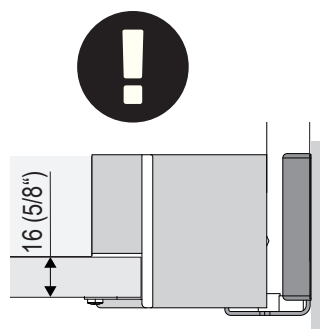
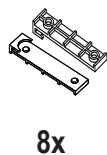

**3b**

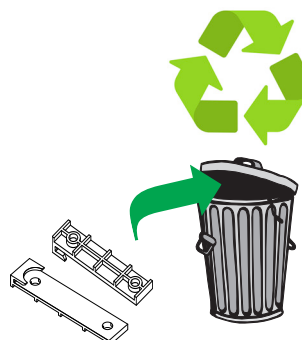
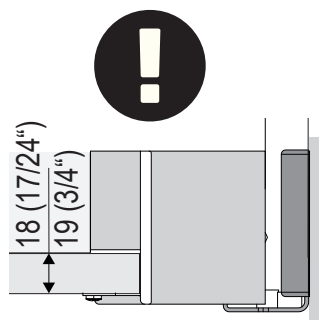
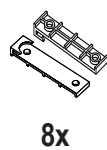

# CONERO

## Inside Pullout 72 H 475



**4**

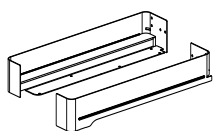

1x

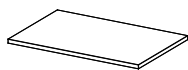

1x

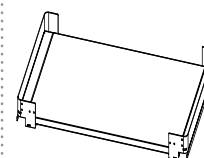
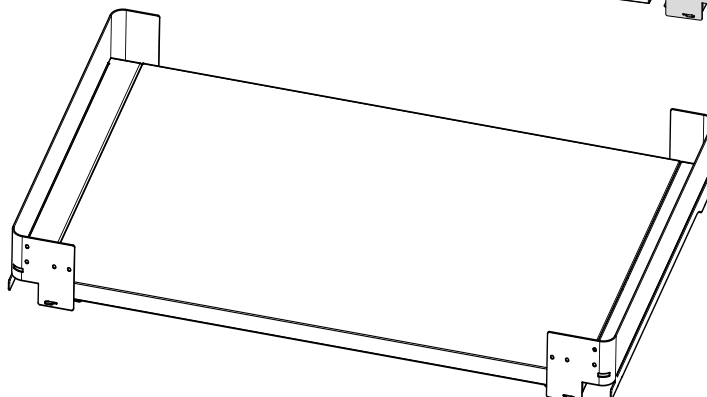
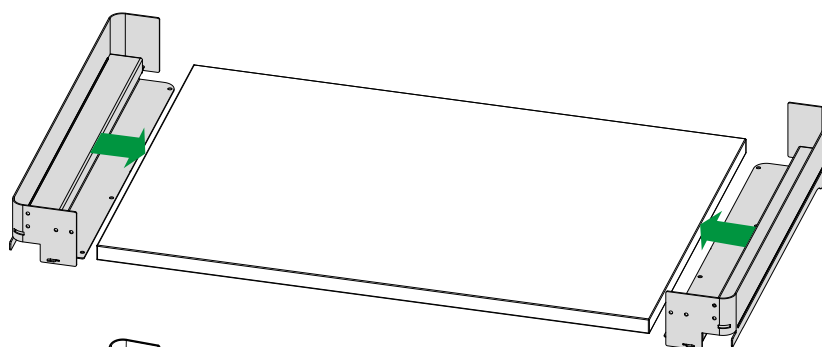

**5a**

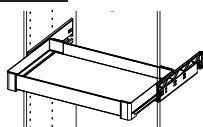

1x

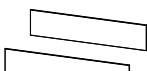

1x

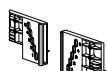

1x



1x

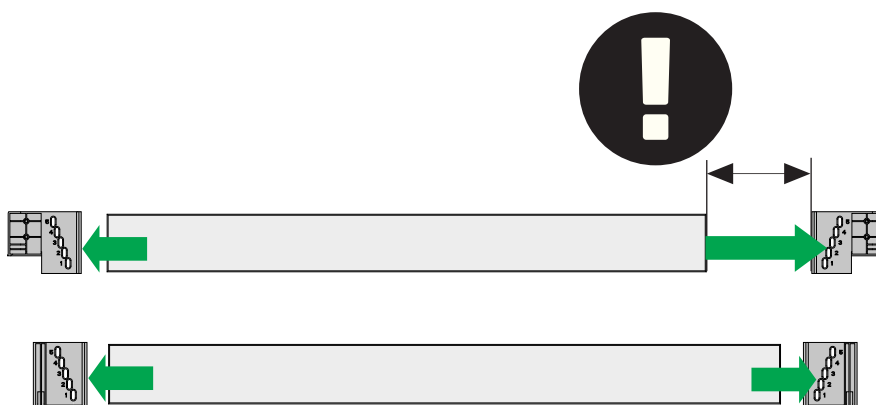

**5b**

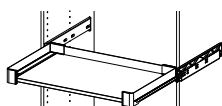

1x

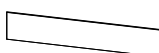

1x

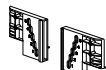

1x

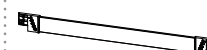

# CONERO

## Inside Pullout 72 H 475



### 6.1

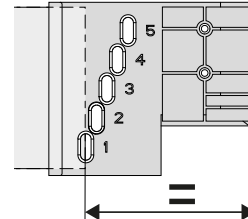
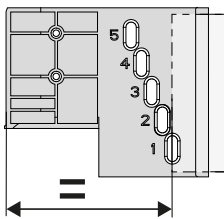
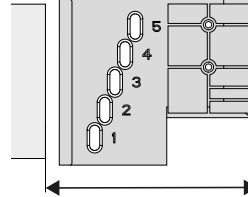
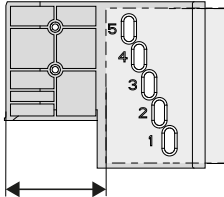
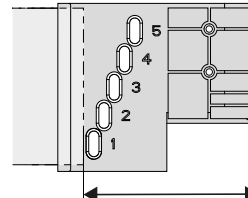
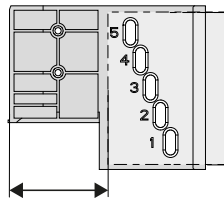
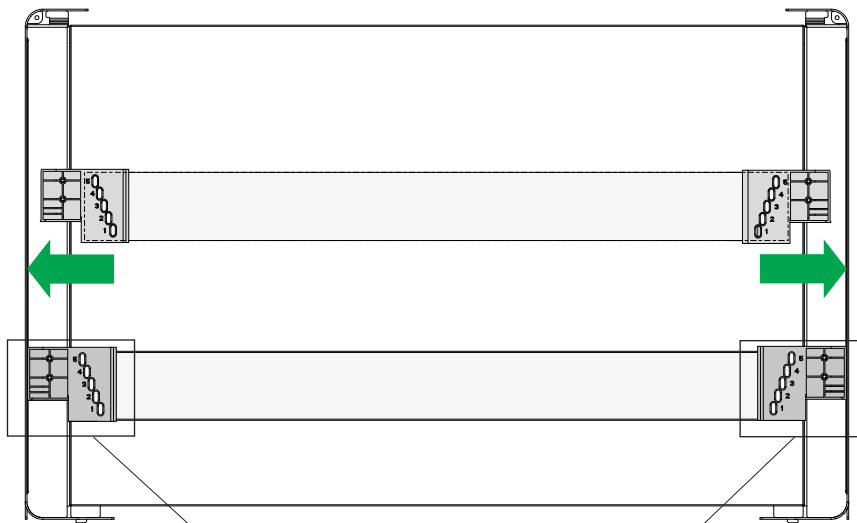

### 6.2a



1x



2x

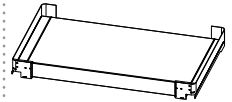
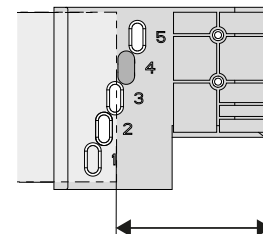
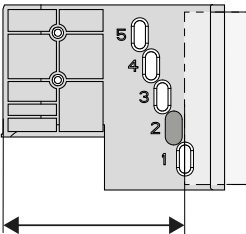
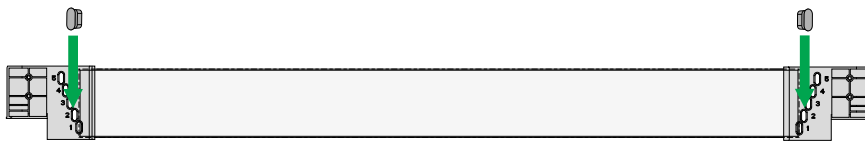

### 6.2b



2x

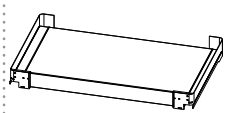
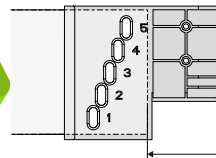
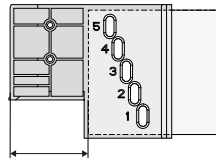
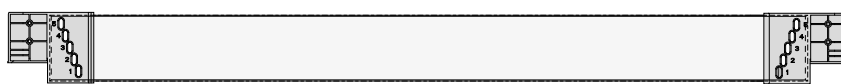

# CONERO

## Inside Pullout 72 H 475



**7.1**

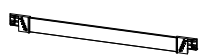

1x

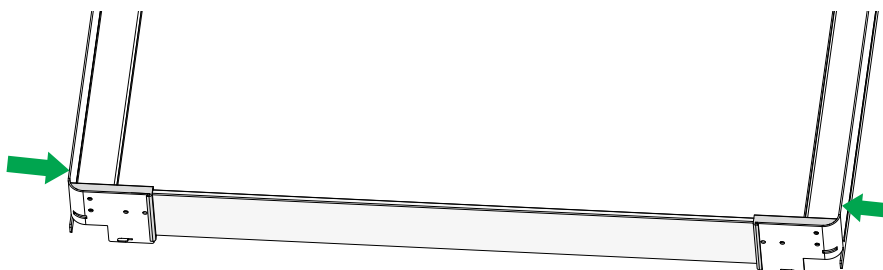

**7.2**

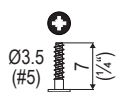

4x

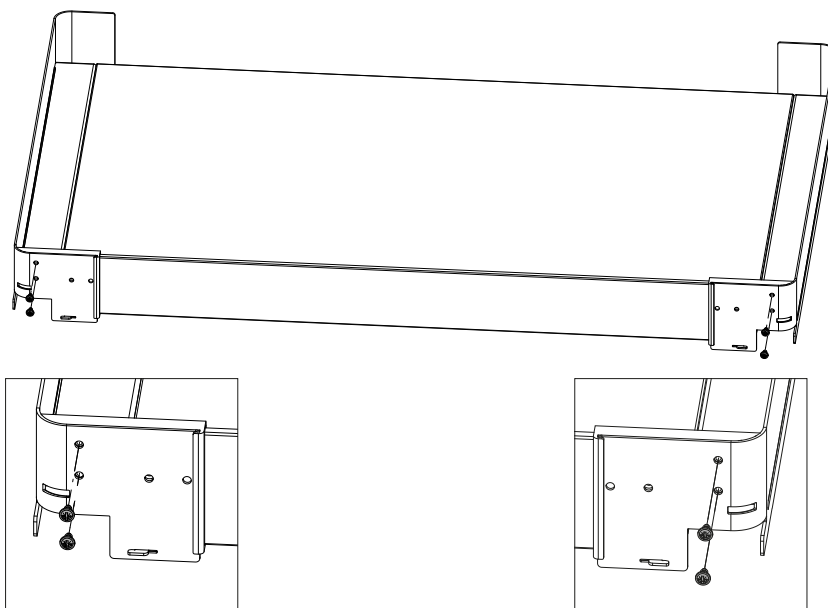

**8.1**

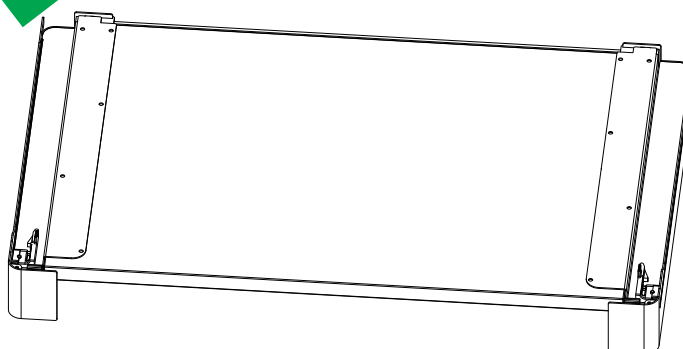
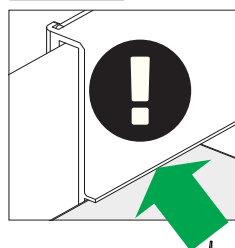
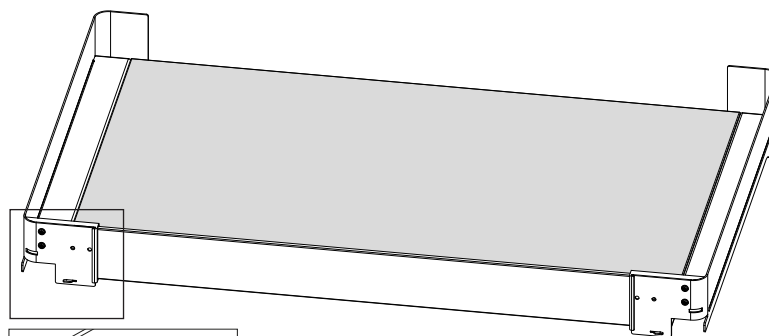

# CONERO

## Inside Pullout 72 H 475



### 8.2

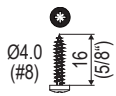

1x

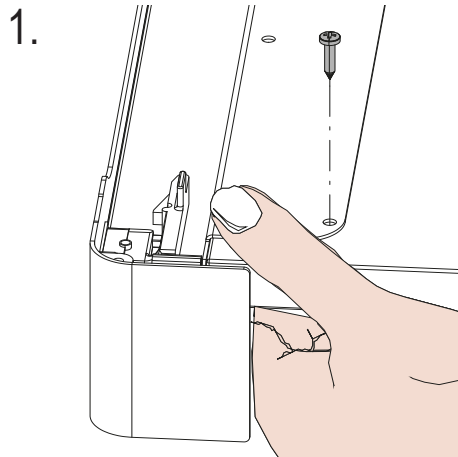

### 8.3

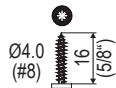

1x



2.

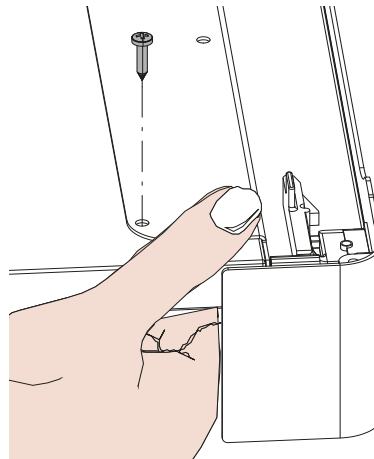

### 8.4

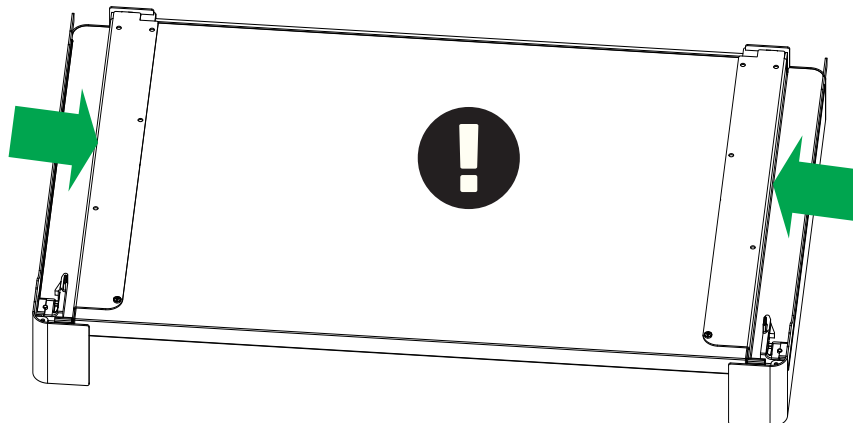

### 8.5

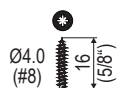

6x

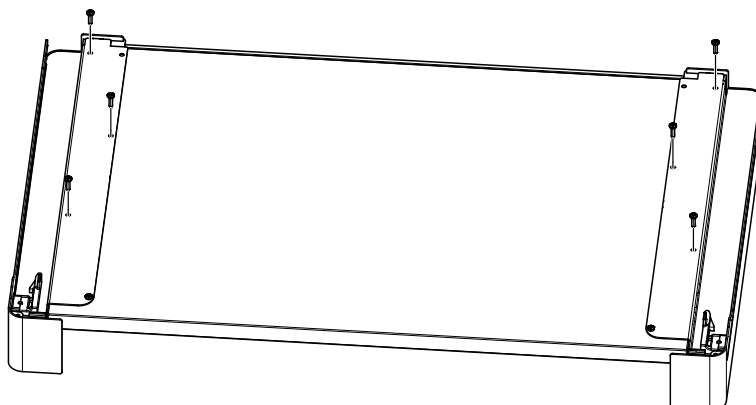

# CONERO

## Inside Pullout 72 H 475



**i**

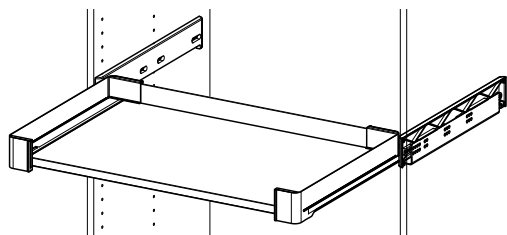
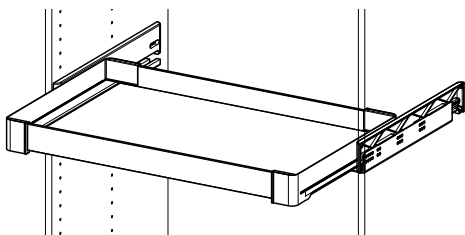

**9a.1**



**11b**

**9a.1**

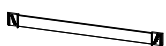
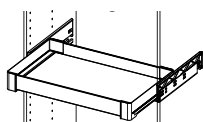

1x

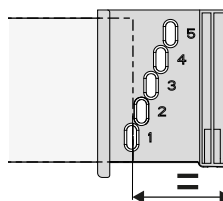
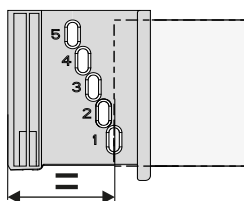
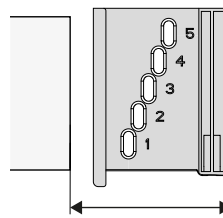
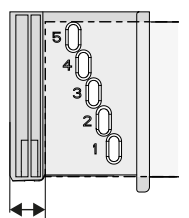
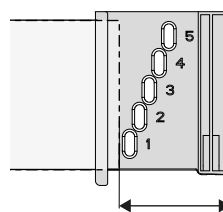
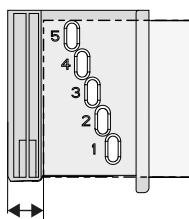
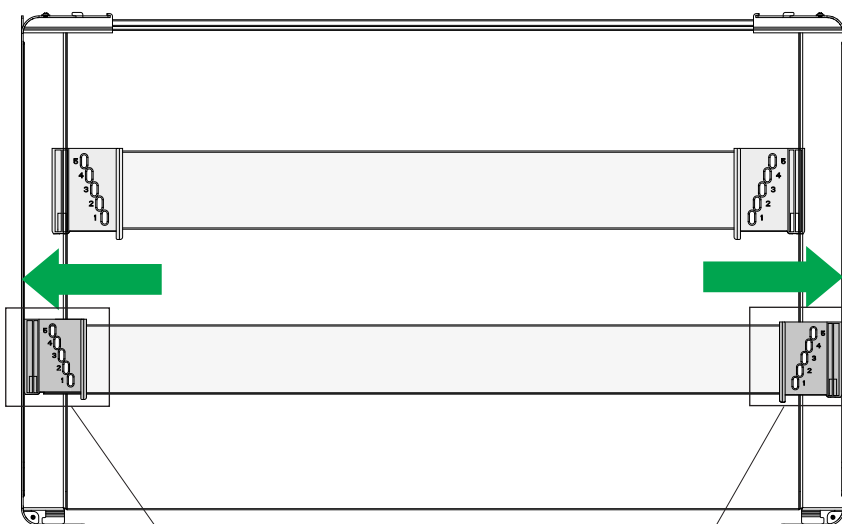

# CONERO

## Inside Pullout 72 H 475



### 9a.2a



2x

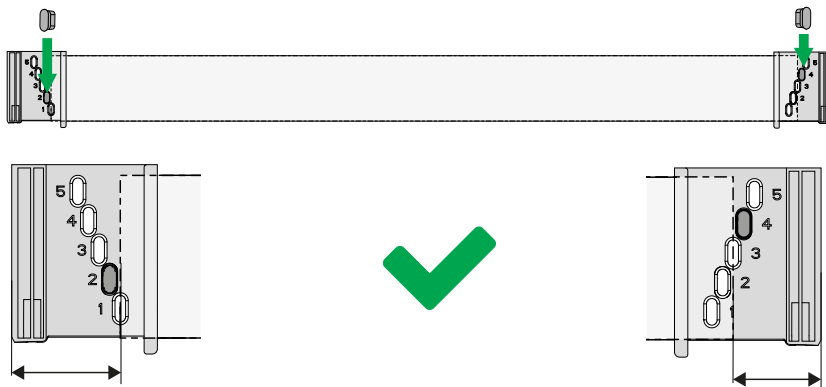

### 9a.2b



2x

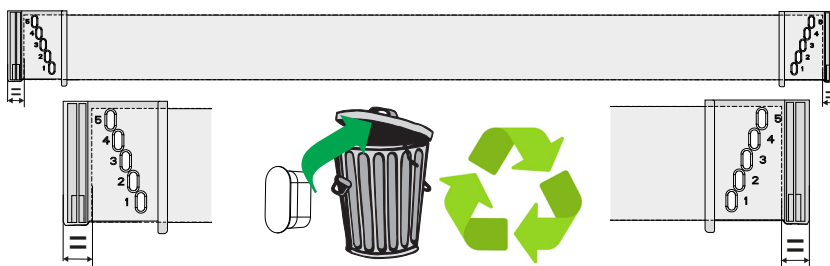

### 9a.3



2x



### 10a

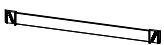

1x

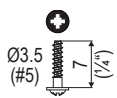

2x

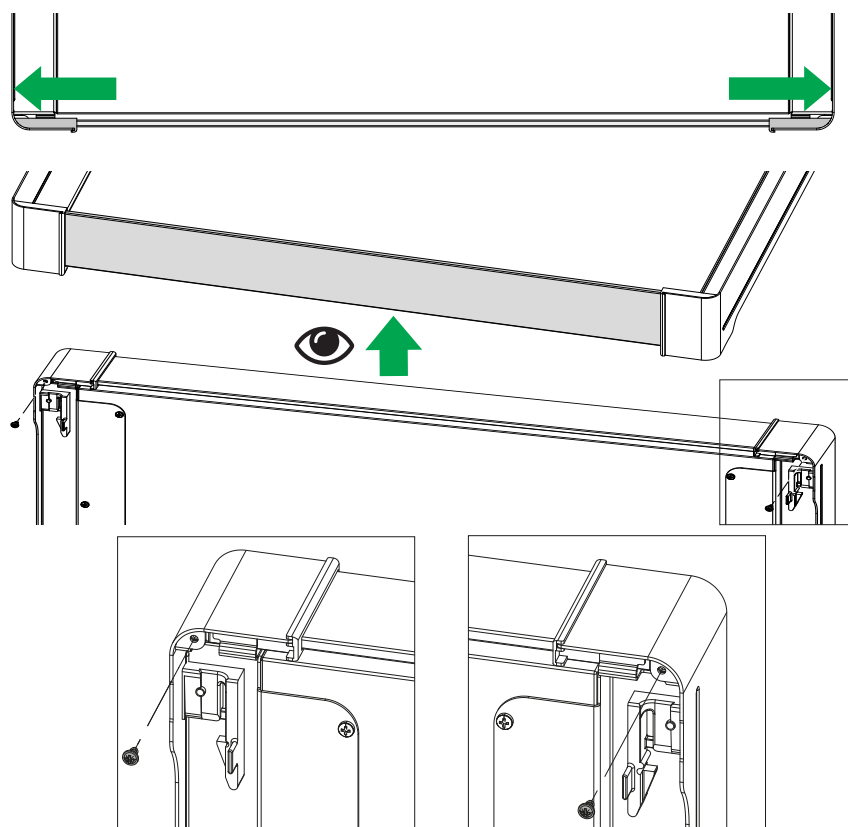



# CONERO

## Inside Pullout 72 H 475



### 10b

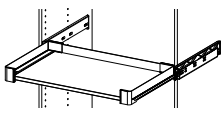

1x



1x

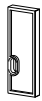

2x



2x

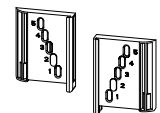
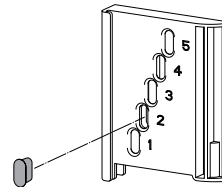
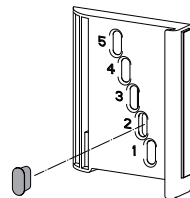
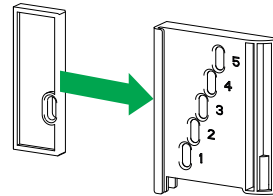
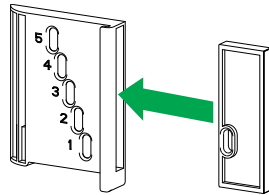

### 11b

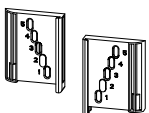

1x

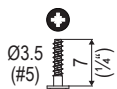

2x

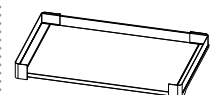
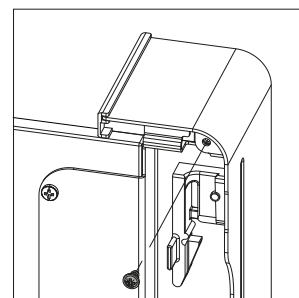
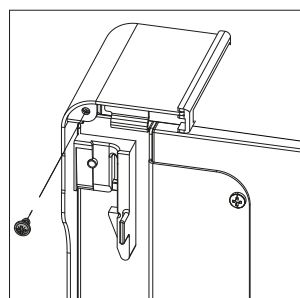
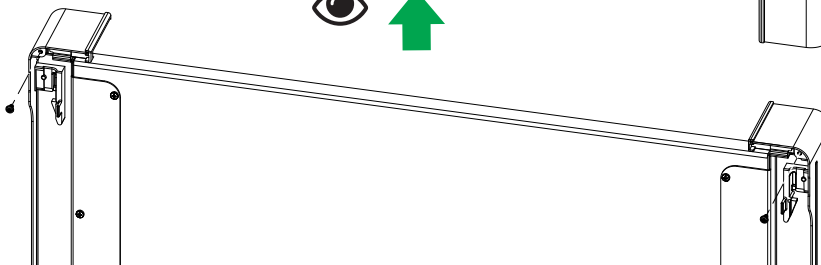
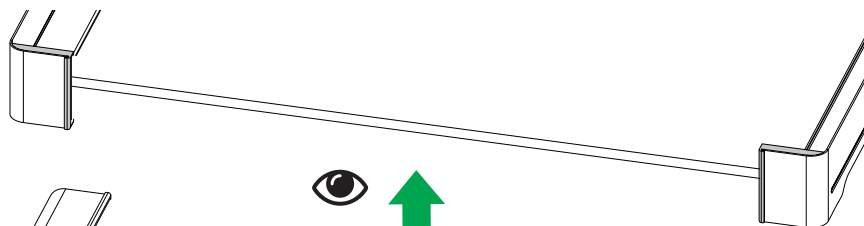
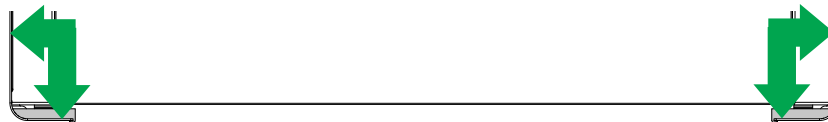

# CONERO

## Inside Pullout 72 H 475



12

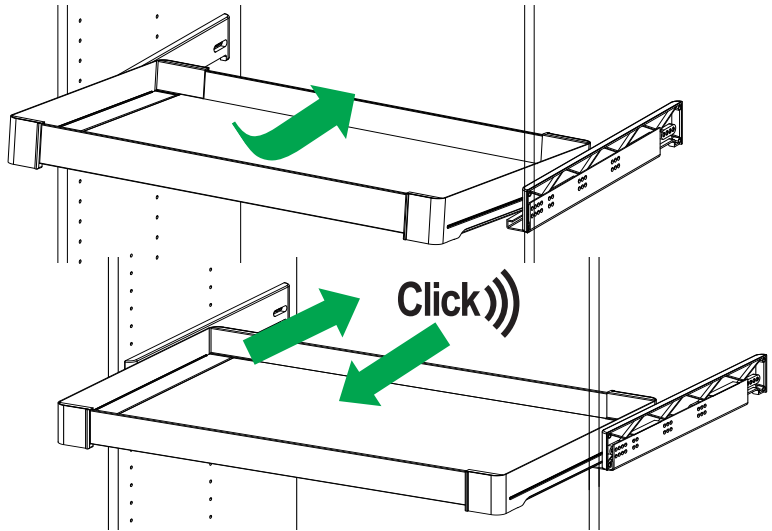

13.1

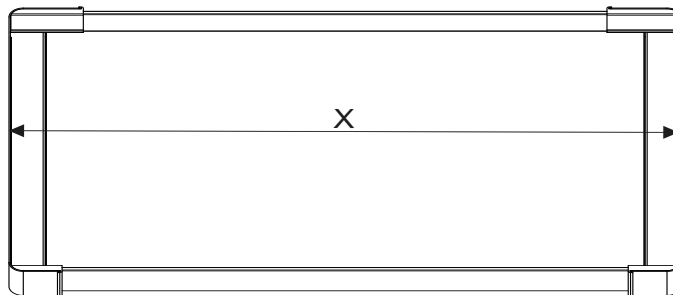
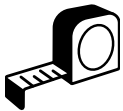

13.2

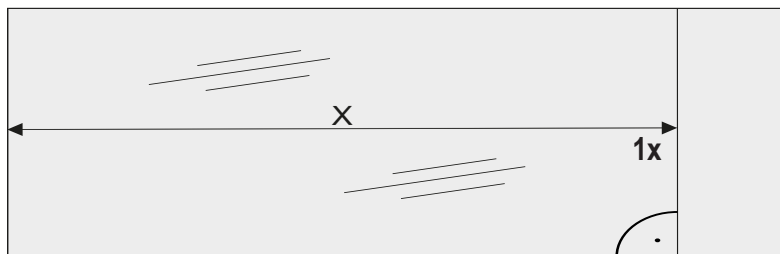
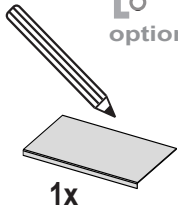

13.3

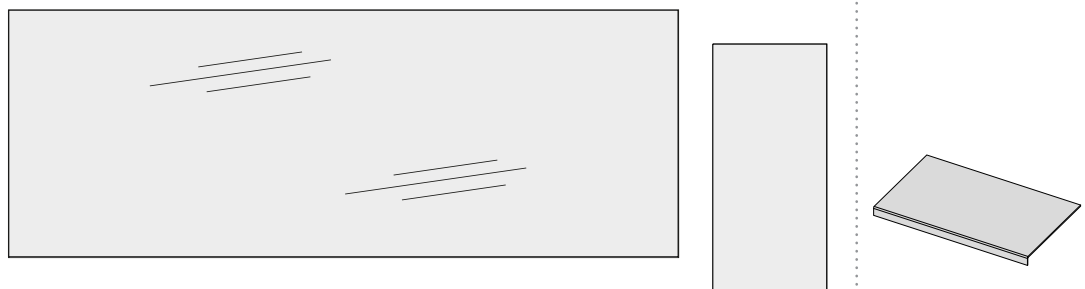

13.4

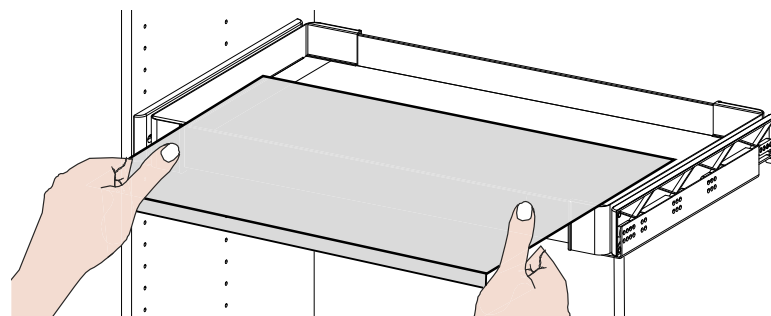
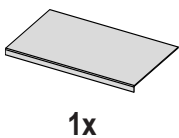

# CONERO

## Inside Pullout 72 H 475

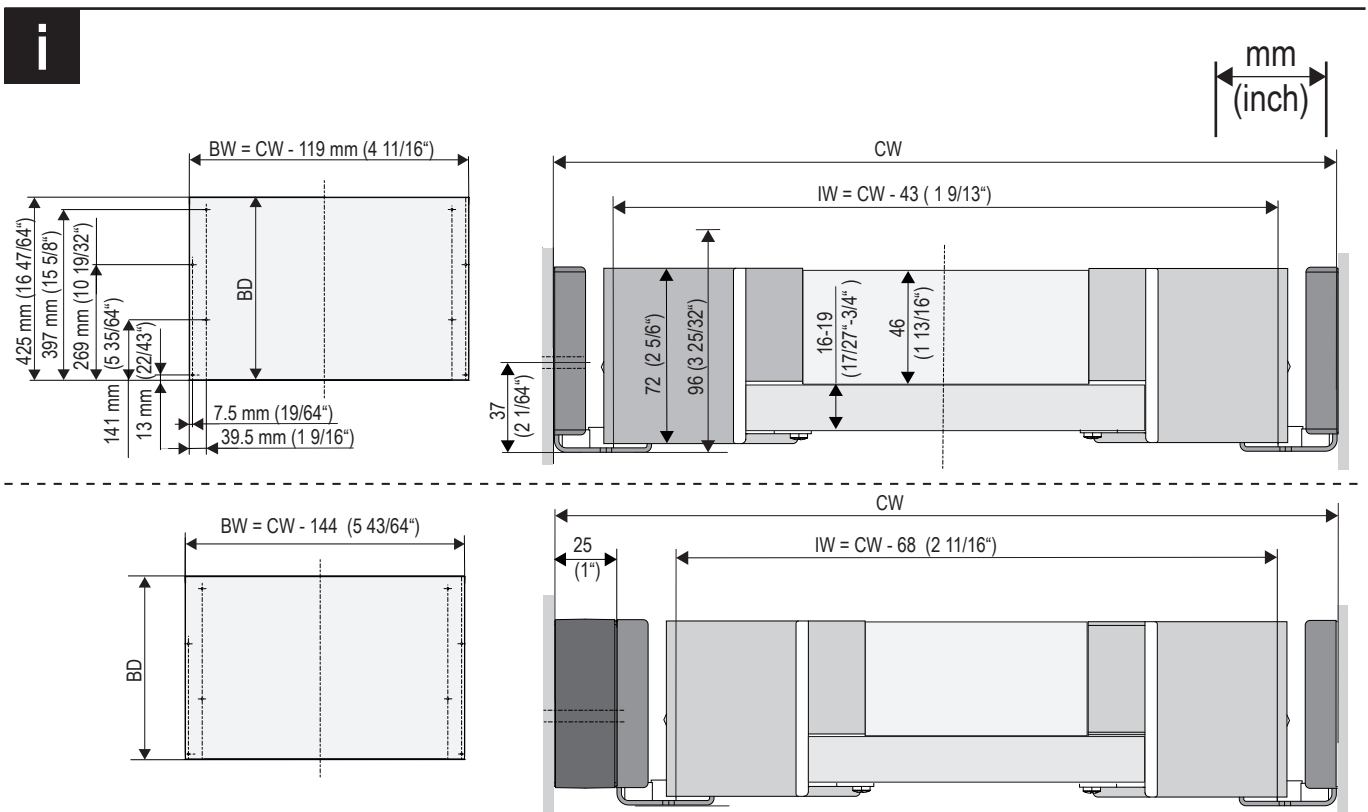
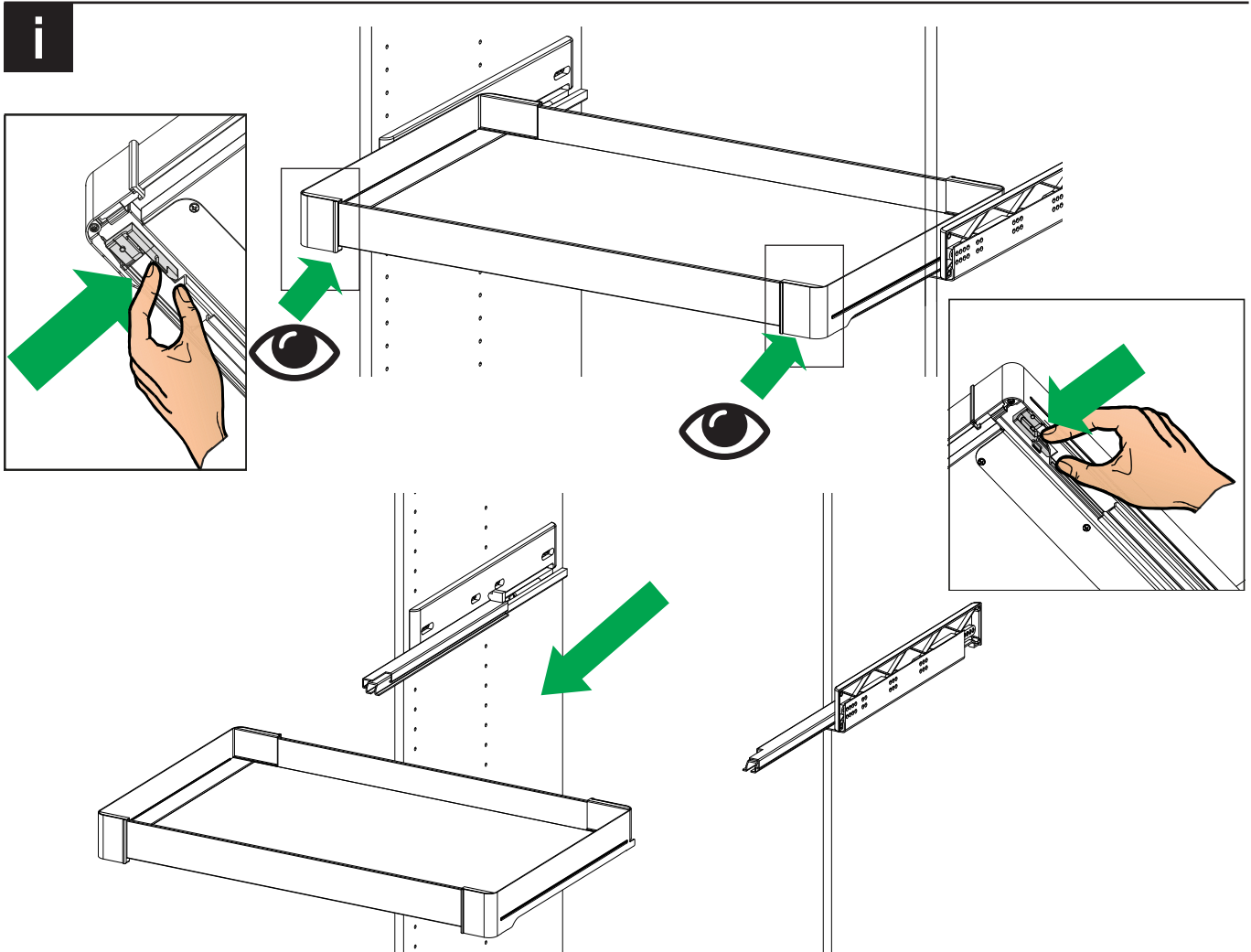

# CONERO

## Inside Pullout 72 H 475



**i**

mm  
(inch)

