

DE Vorderansicht
FR Vue de face
EN Front view
IT Vista frontale
ES Vista frontal

DE Ablängen der Profile
FR Raccourcir les profilés
EN Cutting the profiles to length
IT Taglio a misura dei profili
ES Cortar a medida los perfiles

DE Seitenansicht
FR Vue de côté
EN Side view
IT Vista laterale
ES Vista lateral

DE Draufsicht
FR Vue de dessus
EN Top view
IT Vista dall'alto
ES Vista superior

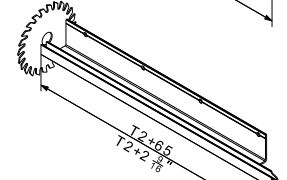
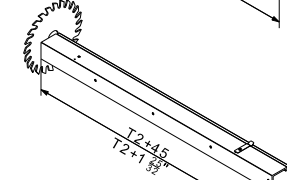
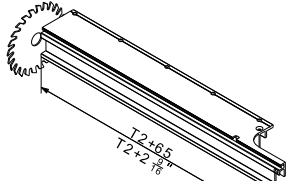
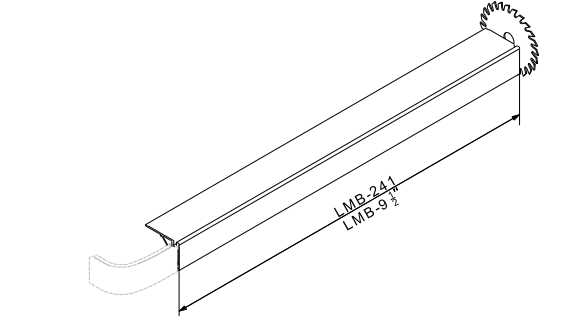
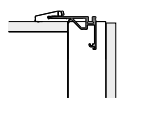
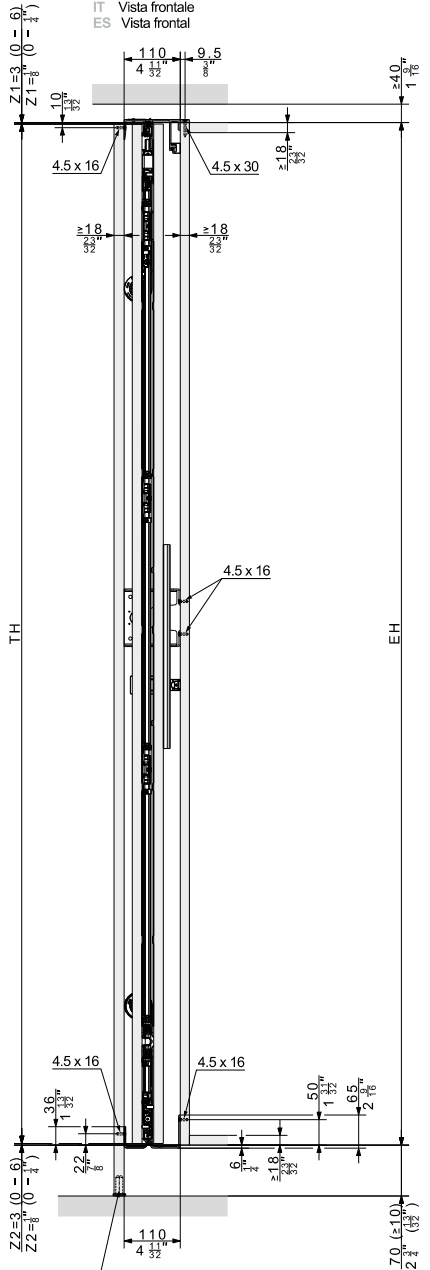

DE ohne Möbelboden
FR Sans fond
EN without base panel
IT senza fondo del mobile
ES sin base

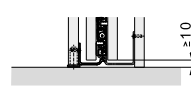

DE mit Bodenprofil, siehe Beipackblatt 52036
FR Avec profil de fond inférieur, voir le mode d'emploi joint 52036
EN with base profile, see leaflet 52036
IT con profilo a pavimento, vedere manuale di istruzioni 52036
ES con perfil para la base: ver hoja de instrucciones 52036

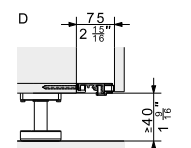

DE Empfehlung: Stelfuss verwenden
FR Recommendation : utiliser un pied de réglage
EN Recommendation: Use adjustable foot
IT Raccomandazione: Utilizzare un piedino regolabile
ES Recomendación: Utilizar un pie ajustable

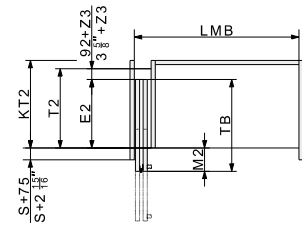
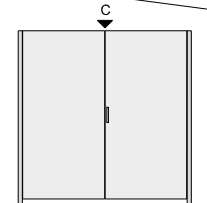

	mm	Inch
T2	TB + 92 + Z3 - M2	TB + 3 5/8" + Z3 - M2
E2	TB - M2	TB - M2
KT2	≥ T2	≥ T2
M2	≥ S + 75 ≤ TB - 390	≥ S + 2 15/16" ≤ TB - 1' 3 11/32"

	mm	Inch
S	18 - 26	3/32" - 1 1/32"
T2	≥ 344	≥ 1' 1 13/32"
TB	440 - 750	1' 5 11/16" - 2' 5 31/32"
TH (III 20)	1200 - 2200	3' 11 1/4" - 7' 2 5/8"
TH (III 25)	1900 - 2700	6' 2 13/16" - 8' 10 5/16"
Z1	0 - 6	0 - 1/4"
Z2	0 - 6	0 - 1/4"
Z3	2 - 5	3/32" - 3/16"
Z4	2 - 5	3/32" - 3/16"
Z5	2 - 5	3/32" - 3/16"

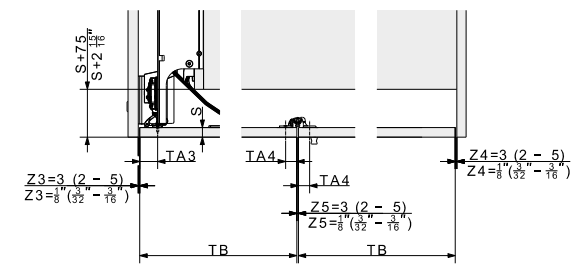
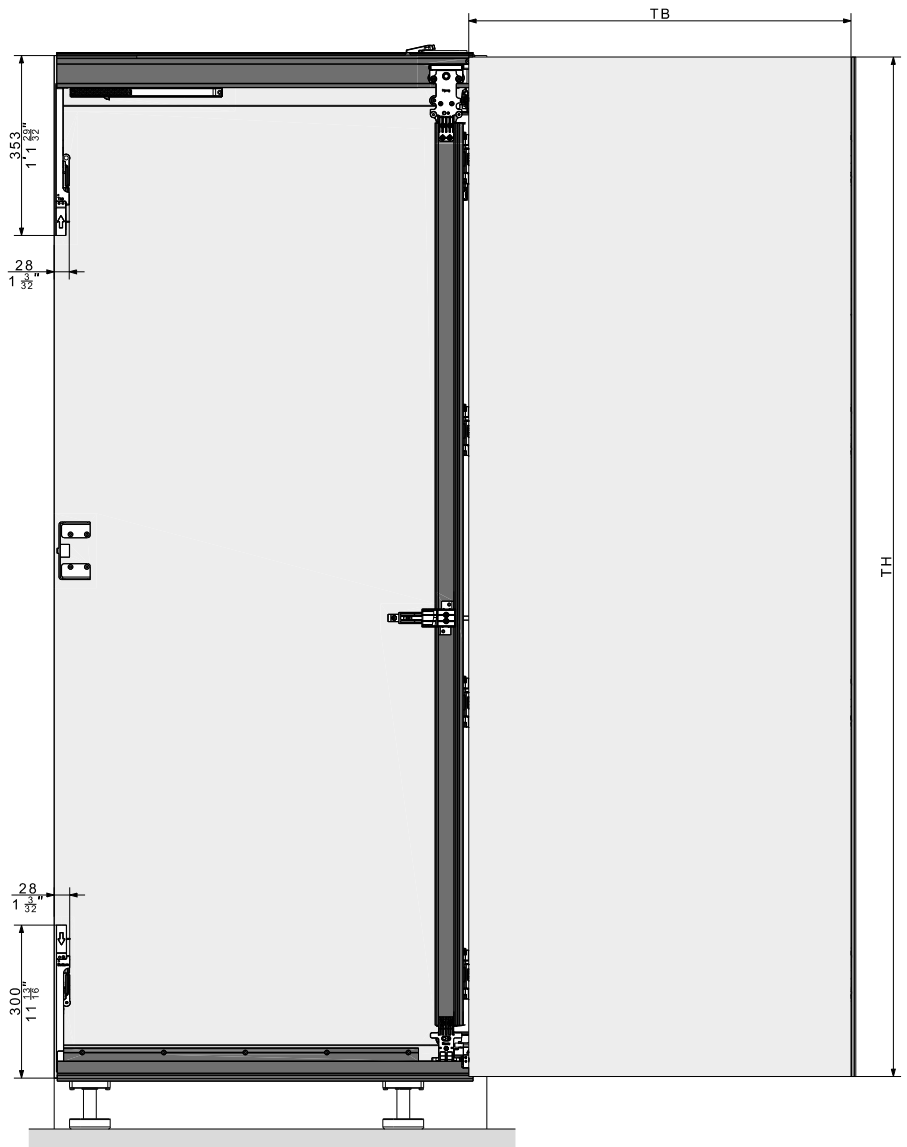

Z3	TA3	Z5	TA4
2 mm (3/32")	29 mm (1 1/8")	2 mm (3/32")	22.5 mm (7/8")
3 mm (1/8")	28 mm (1 1/8")	3 mm (1/8")	22 mm (7/8")
4 mm (5/32")	27 mm (1 1/8")	4 mm (5/32")	21.5 mm (27/32")
5 mm (3/16")	26 mm (1 1/8")	5 mm (3/16")	21 mm (13/16")

DE Türe vorstehend
FR Porte en saillie
EN Protruding door
IT Porta sporgente
ES Puerta saliente

DE Türe bündig
FR Porte affleurante
EN Flush door
IT Porta complanare
ES Puerta enrasada

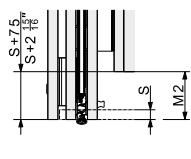
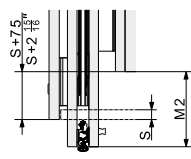

DE Abkürzungen / FR Abréviations / EN Abbreviations / IT Abbreviazioni / ES Abreviaturas

DE	FR	EN	IT	ES
E2 Einschubtiefe	Profondeur d'escamotage	Slide-in depth	Profondità di inserimento	Profundidad de introducción
EH Einbauhöhe	Hauteur d'encastrement	Installation height	Altezza d'incasso	Altura de montaje
KT2 Korpus tiefe	Profondeur de corps	Cabinet depth	Profondità mobile	Profundidad del mueble
LMB Lichtmassbreite	Largeur intérieure	Inside clearance	Larghezza luce	Ancho interior
M2 Türüberstand über Korpus	Saillie de la porte par rapport au corps	Door projection over cabinet	Sporgenza anta sopra il mobile	Solape de la puerta sobre el cuerpo
S Türdicke	Epaisseur de porte	Door thickness	Spessore anta	Grosor de la puerta
T2 Beschlagtiefe	Profondeur de ferrure	Hardware depth	Profondità ferramenta	Profundidad del herraje
TA Topfachsabstand	Ecartement d'axe de la charnière invisible	Axis-centre distance of concealed hinge	Distanza scatola/asse	Distancia de la cazoleta
TB Türbreite	Largeur de porte	Door width	Larghezza anta	Ancho de puerta
TH Türhöhe	Hauteur de porte	Door height	Altezza anta	Altura de puerta
Z Luftzwischenraum	Jeu dans l'espacement	Air gap	Traferro d'ania	Espacio libre

DE Hawa Folding Concepta III Pull 2-türig links
FR Hawa Folding Concepta III Pull 2 portes, à gauche
EN Hawa Folding Concepta III Pull 2 doors, left
IT Hawa Folding Concepta III Pull 2 ante, a sinistra
ES Hawa Folding Concepta III Pull 2 puertas izquierda

Hawa Folding Concepta III Pull 2-türig links
161967 V03 1/2

DE Aussenseite A
FR Face extérieure A
EN Outer face A
IT Lato esterno A
ES Lateral exterior A

DE Beschlagseite B
FR Côte de la ferrure B
EN Fitting side B
IT Lato ferramenta B
ES Lado del herraje B

DE Falttüre Folding Concepta III 25 Pull
FR Porte pliante Folding Concepta III 25 Pull
EN Folding Concepta III 25 Pull folding door
IT Porta a libro Folding Concepta III 25 Pull
ES Puerta plegable Folding Concepta III 25 Pull

DE Falttüre Folding Concepta III 20 Pull
FR Porte pliante Folding Concepta III 20 Pull
EN Folding Concepta III 20 Pull folding door
IT Porta a libro Folding Concepta III 20 Pull
ES Puerta plegable Folding Concepta III 20 Pull

DE Drehtüre Folding Concepta III 25 Pull
FR Porte tournante Folding Concepta III 25 Pull
EN Folding Concepta III 25 Pull pivot door
IT Porta girevole Folding Concepta III 25 Pull
ES Puerta giratoria Folding Concepta III 25 Pull

DE Drehtüre Folding Concepta III 20 Pull
FR Porte tournante Folding Concepta III 20 Pull
EN Folding Concepta III 20 Pull pivot door
IT Porta girevole Folding Concepta III 20 Pull
ES Puerta giratoria Folding Concepta III 20 Pull

DETAIL D 2:1 DE Siehe Beipackblatt 52124
FR Voir le mode d'emploi joint 52124
EN See leaflet 52124
IT Vedere manuale di istruzioni 52124
ES Ver hoja de instrucciones 52124

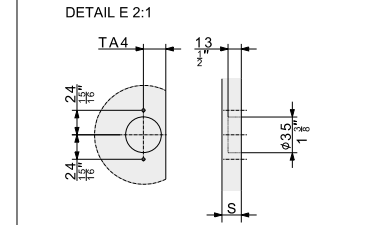
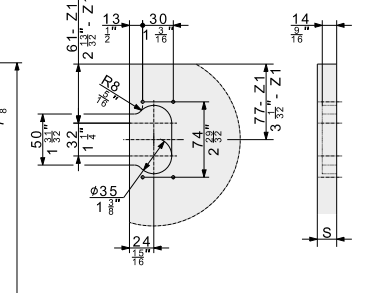
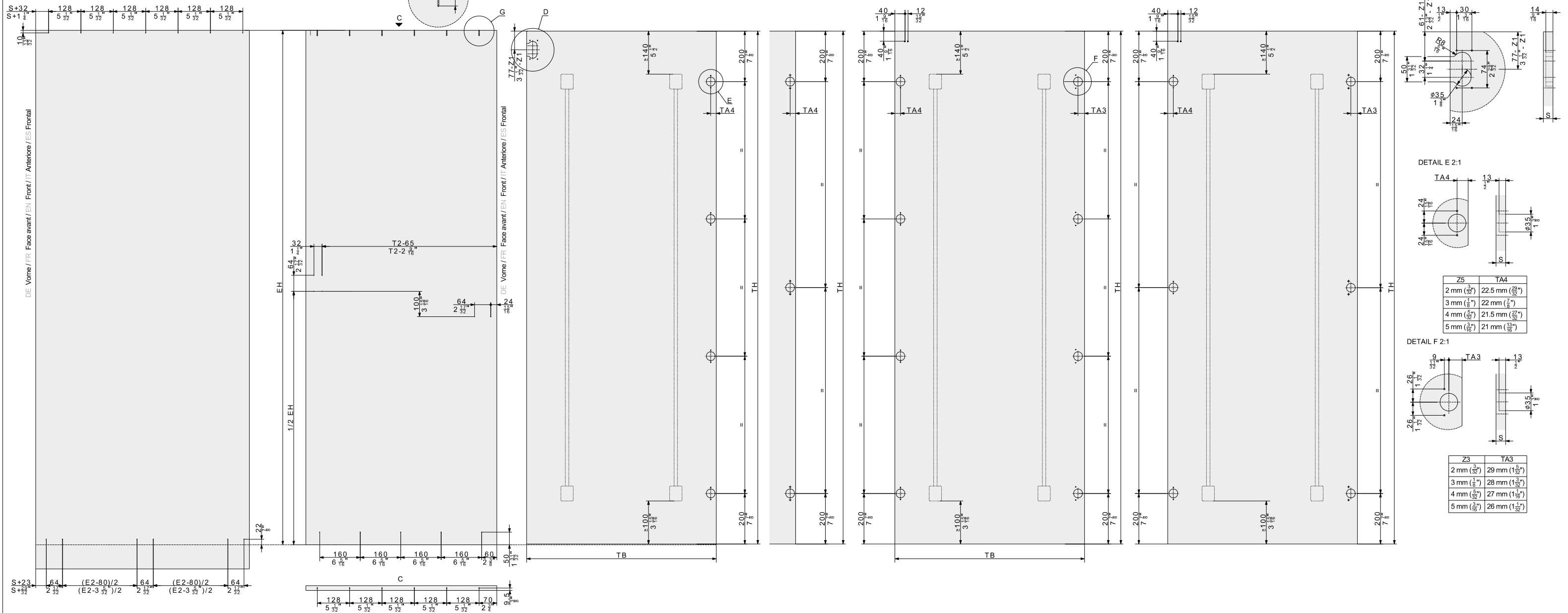

Z5	TA4
2 mm ($\frac{3}{32}$)	22.5 mm ($\frac{9}{16}$)
3 mm ($\frac{1}{8}$)	22 mm ($\frac{7}{8}$)
4 mm ($\frac{5}{16}$)	21.5 mm ($\frac{7}{8}$)
5 mm ($\frac{3}{8}$)	21 mm ($\frac{13}{16}$)

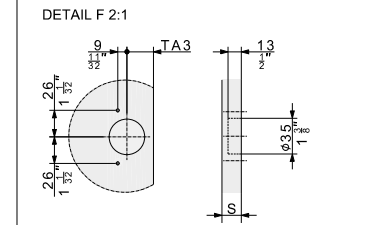

Z3	TA3
2 mm ($\frac{3}{32}$)	29 mm ($1\frac{1}{8}$)
3 mm ($\frac{1}{8}$)	28 mm ($1\frac{1}{8}$)
4 mm ($\frac{5}{16}$)	27 mm ($1\frac{1}{8}$)
5 mm ($\frac{3}{8}$)	26 mm ($1\frac{1}{8}$)

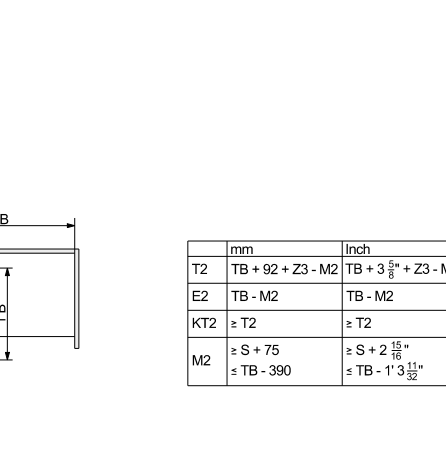
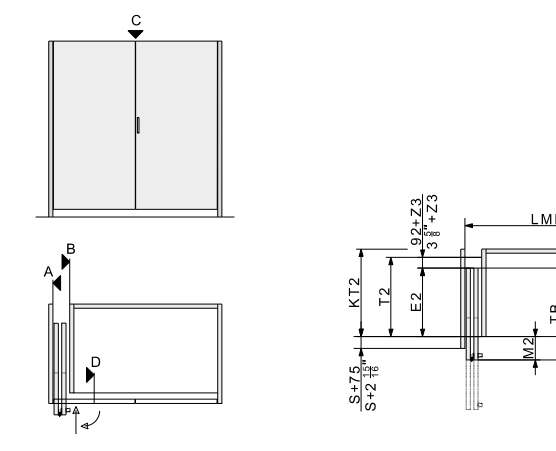

	mm	Inch
T2	TB + 92 + Z3 - M2	TB + 3 $\frac{5}{8}$ " + Z3 - M2
E2	TB - M2	TB - M2
KT2	≥ T2	≥ T2
M2	≥ S + 75	≥ S + 2 $\frac{15}{16}$ "
	≤ TB - 390	≤ TB - 1' 3 $\frac{11}{16}$ "

	mm	Inch
S	18 - 26	$\frac{23}{32}$ " - 1 $\frac{1}{32}$ "
T2	≥ 344	≥ 1' 1 $\frac{17}{32}$ "
TB	440 - 750	1' 5 $\frac{1}{16}$ " - 2' 5 $\frac{11}{32}$ "
TH (III 20)	1200 - 2200	3' 11 $\frac{1}{4}$ " - 7' 2 $\frac{3}{8}$ "
TH (III 25)	1900 - 2700	6' 2 $\frac{13}{16}$ " - 8' 10 $\frac{3}{16}$ "
Z1	0 - 6	0 - $\frac{1}{4}$ "
Z2	0 - 6	0 - $\frac{1}{4}$ "
Z3	2 - 5	$\frac{3}{32}$ " - $\frac{3}{16}$ "
Z4	2 - 5	$\frac{3}{32}$ " - $\frac{3}{16}$ "
Z5	2 - 5	$\frac{3}{32}$ " - $\frac{3}{16}$ "

DE Schrankdeckel
FR Couverture d'armoire
EN Cabinet lid
IT Coperchio del mobile
ES Tapa del armario

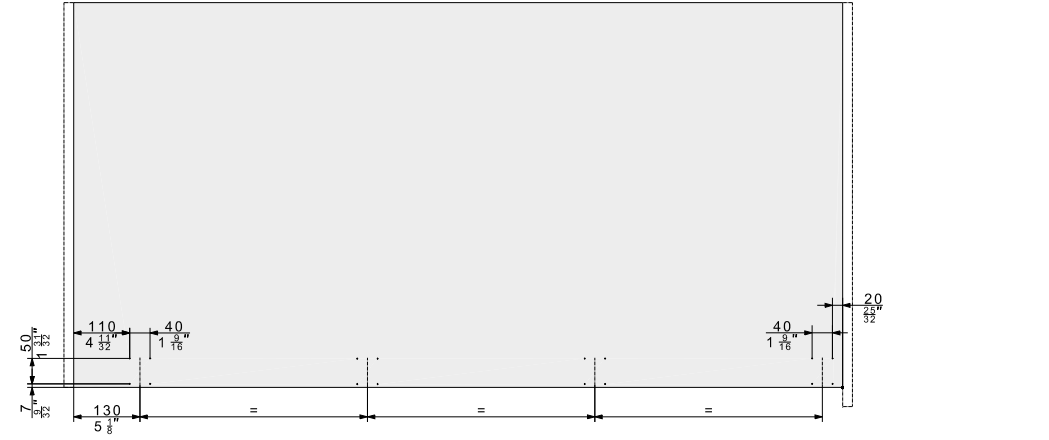

DE Abkürzungen / FR Abréviations / EN Abbreviations / IT Abbreviazioni / ES Abreviaturas

	DE	FR	EN	IT	ES
E2	Einschubtiefe	Profondeur d'escamotage	Slide-in depth	Profondità di inserimento	Profundidad de introducción
EH	Einbauhöhe	Hauteur d'encastrement	Installation height	Altezza d'incasso	Altura de montaje
KT2	Korpusstiefe	Profondeur de corps	Cabinet depth	Profondità mobile	Profundidad del mueble
LMB	Lichtmassbreite	Largeur intérieure	Inside clearance	Larghezza luce	Ancho interior
M2	Türüberstand über Korpus	Saillie de la porte par rapport au corps	Door projection over cabinet	Sporgenza anta sopra il mobile	Solape de la puerta sobre el cuerpo
S	Türdicke	Epaisseur de porte	Door thickness	Spessore anta	Grosor de la puerta
T2	Beschlagtiefe	Profondeur de ferrure	Hardware depth	Profondità ferramenta	Profundidad del herraje
TA	Topflachsabstand	Ecartement d'axe de la charnière invisible	Axis-centre distance of concealed hinge	Distanza scatolaina asse	Distancia de la cazoleta
TB	Türbreite	Largeur de porte	Door width	Larghezza anta	Ancho de puerta
TH	Türhöhe	Hauteur de porte	Door height	Altezza anta	Altura de puerta
Z	Luftzwischenraum	Jeu dans l'espacement	Air gap	Traferro d'aria	Espacio libre

DE Hawa Folding Concepta III Pull 2-türig links
FR Hawa Folding Concepta III Pull 2 portes, à gauche
EN Hawa Folding Concepta III Pull 2 doors, left
IT Hawa Folding Concepta III Pull 2 ante, a sinistra
ES Hawa Folding Concepta III Pull 2 puertas izquierda

Hawa Folding Concepta III Pull 2-türig links
161967 V03 2/2

Gar.Verf.: 19.12.2023 SSI
Rev.Verf.: 19.06.2024 BBU